









STRUTTURA

-  MATERIALE: acciaio
-  FINITURA: acciaio spazzolato
-  INDOOR/OUTDOOR
-  PESO: 10 kg

NASTRO

-  MATERIALE: polipropilene
-  COLORE: rosso
-  COLORE: blu
-  COLORE: nero

GRAFICA

-  MONOFACCIALE/BIFACCIALE
-  PERSONALIZZAZIONE

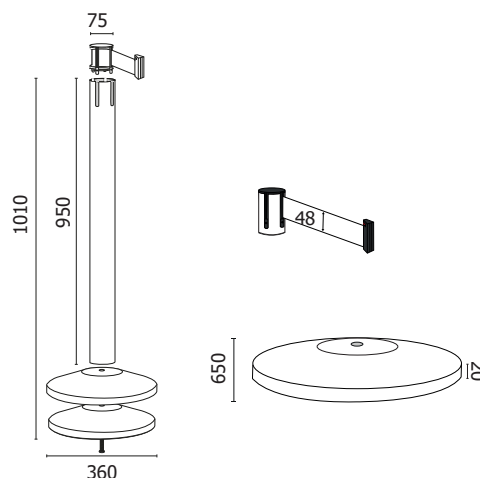

Colonnine tendinastro con finitura in acciaio spazzolato o nero opaco. Nastro in polipropilene retrattile con sistema autofrenante lunghezza 5 mt con clip di sicurezza finale. Personalizzabile da entrambi i lati con logo ad 1 o più colori. Peso totale kg 10. Anello antiruggine in ABS nero per utilizzo interno ed esterno.

DIMENSIONI PRODOTTO (mm)

Codice	Finitura colonnina	Colore nastro	Dim. ØxH	L nastro	Cod. EAN
STOP500/R	acciaio spazzolato	rosso	360x1010	5 metri	0768855778474
STOP500/B	acciaio spazzolato	blu	360x1010	5 metri	0768855778450
STOP500/N	acciaio spazzolato	nero	360x1010	5 metri	0768855778467

MISURE IMBALLO (mm/kg)

n. art. per imballo	Dim. imballo	Peso art.	Peso art. e imballo
2	390x1020x150	10,00	22,00