









STRUTTURA

-  MATERIALE0: acciaio
-  FINITURA: acciaio spazzolato
-  INDOOR/OUTDOOR
-  PESO: 10 kg

GRAFICA

-   MONOFACCIALE/BIFACCIALE
-  PERSONALIZZAZIONE

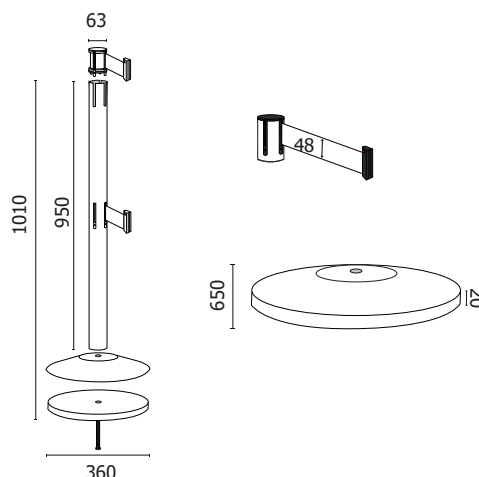

NASTRO SUPERIORE

-  MATERIALE: polipropilene
-  COLORE: rosso
-  COLORE: blu
-  COLORE: nero
-  COLORE: bianco
-  COLORE: verde
-  COLORE: giallo
-  COLORE: arancione
-  COLORE: bianco/rosso
-  COLORE: nero/giallo
-  COLORE: grigio

NASTRO INFERIORE

-  MATERIALE: polipropilene
-  COLORE: rosso
-  COLORE: blu
-  COLORE: nero

Colonnine tendinastro con finitura in acciaio spazzolato o nero opaco. Doppio nastro in polipropilene retrattile con sistema autofrenante lunghezza 3 mt con clip di sicurezza finale. Personalizzabile da entrambi i lati con logo ad 1 o più colori. Peso totale kg 10. Anello antiruggine in ABS nero per utilizzo interno ed esterno.

DIMENSIONI PRODOTTO (mm)

| Codice | Dim. ØxH | Lunghezza nastro | Cod. EAN |
|---------|----------|------------------|---------------|
| STOP51D | 360x1010 | 3 metri | 0768855778443 |

MISURE IMBALLO (mm/kg)

| n. art. per imballo | Dim. imballo | Peso art. | Peso art. e imballo |
|---------------------|--------------|-----------|---------------------|
| 2 | 390x1020x150 | 10,00 | 22,00 |