

TEND005 Colonnine segnapercorso

SCHEMA TECNICA





PROTEZIONE ANTIRUGGINE
ALLA FINE DELLA COLONNA











STRUTTURA

-  MATERIALE: metallo
-  FINITURA: bianco
-  INDOOR/OUTDOOR
-  PESO: 10,5 kg

GRAFICA

-  MONOFACCIALE/BIFACCIALE
-  PERSONALIZZAZIONE

NASTRO

-  MATERIALE: polipropilene
-  COLORE: rosso
-  COLORE: blu
-  COLORE: nero
-  COLORE: bianco
-  COLORE: verde
-  COLORE: giallo
-  COLORE: arancione
-  COLORE: bianco/rosso
-  COLORE: nero/giallo

Colonnine Tendilinea con base piatta antinciampo e antiscivolo, montante in metallo con finitura bianco. Peso totale kg 10,5. Tappo superiore con tre clip riceventi e nastro retrattile in polipropilene di lunghezza 3 m con sistema auto-frenante e clip di sicurezza, personalizzabile da entrambi i lati con logo ad 1 o più colori. Dotate di anello antiruggine in ABS nero per utilizzo interno ed esterno.

TEND005

Colonnine segnapercorso

SCHEDA TECNICA

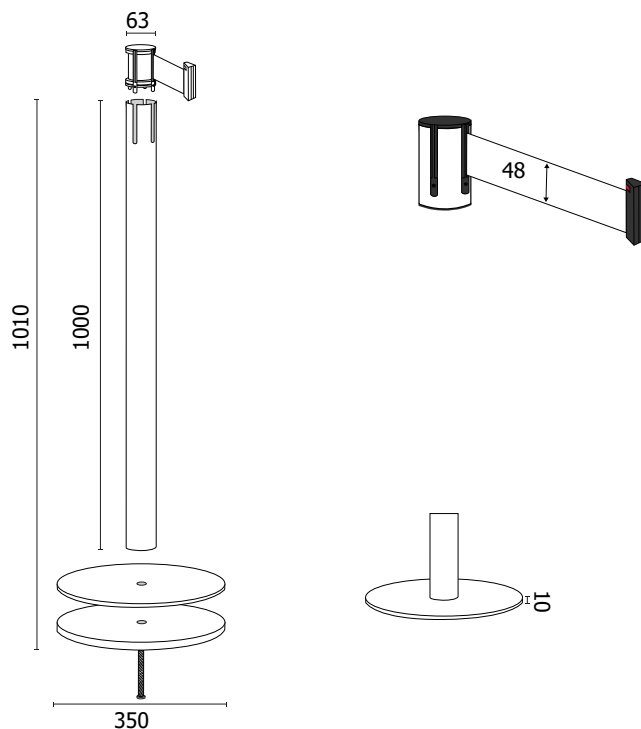

DIMENSIONI PRODOTTO (mm)

Codice	Colore nastro	Dim. ØxH	Finitura colonnina	L nastro	Cod. EAN
TEND005/R	rosso	350x1010	bianco	3 metri	0768855758605
TEND005/B	blu	350x1010	bianco	3 metri	0768855758582
TEND005/N	nero	350x1010	bianco	3 metri	0768855758599
TEND005/GN	giallo nero	350x1010	bianco	3 metri	0768855758643
TEND005/BR	bianco rosso	350x1010	bianco	3 metri	0768855758636
TEND005/BI	bianco	350x1010	bianco	3 metri	0768855758629
TEND005/V	verde	350x1010	bianco	3 metri	0768855758612
TEND005/AR	arancio	350x1010	bianco	3 metri	0755899261772
TEND005/GI	giallo	350x1010	bianco	3 metri	0755899261789

MISURE IMBALLO (mm/kg)

Codice	n. art. per imballo	Dim. imballo	Peso art.	Peso art. e imballo
TEND005/R	2	390x1020x150	10,50	23,00
TEND005/B	2	390x1020x150	10,50	23,00
TEND005/N	2	390x1020x150	10,50	23,00
TEND005/GN	2	390x1020x150	10,50	23,00
TEND005/BR	2	390x1020x150	10,50	23,00
TEND005/BI	2	390x1020x150	10,50	23,00
TEND005/V	2	390x1020x150	10,50	23,00
TEND005/AR	2	390x1020x150	10,50	23,00
TEND005/GI	2	390x1020x150	10,50	23,00