



STOP51T Colonnine segnapercorso

SCHEMA TECNICA





PROTEZIONE ANTIRUGGINE
ALLA FINE DELLA COLONNA



STRUTTURA

-  MATERIALE: PVC
-  INDOOR/OUTDOOR
-  PESO: 9 kg

GRAFICA

-  MONOFACCIALE/BIFACCIALE
-  PERSONALIZZAZIONE: nastro e colonna

NASTRO

-  MATERIALE: polipropilene
-  COLORE: rosso
-  COLORE: blu
-  COLORE: nero
-  COLORE: bianco
-  COLORE: verde
-  COLORE: giallo
-  COLORE: arancione
-  COLORE: bianco/rosso
-  COLORE: nero/giallo

Colonnine tendinastro in PVC trasparente, dotate di sistema tendinastro autofrenante e 3 agganci riceventi. Colonna personalizzabile inserendo all'interno elementi decorativi o grafica intercambiabile. Base con copertura in metallo verniciato a polveri nero opaco. Nastro retrattile in polipropilene altezza 48 mm lunghezza 3 mt con clip di sicurezza, personalizzabile da entrambi i lati con logo ad 1 o più colori. Peso totale kg 9. Anello antiruggine in ABS nero per utilizzo interno ed esterno.

STOP51T

Colonnine segnapercorso

SCHEDA TECNICA

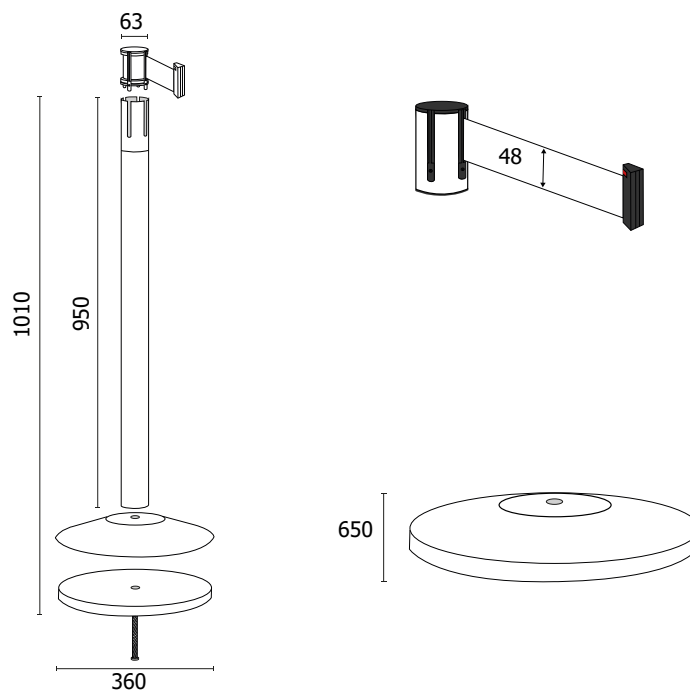

DIMENSIONI PRODOTTO (mm)

Codice	Colore nastro	Dim. ØxH	Lunghezza nastro	Cod. EAN
STOP51T/R	rosso	360x1010	3 metri	0768855778511
STOP51T/B	blu	360x1010	3 metri	0768855778511
STOP51T/N	nero	360x1010	3 metri	0768855778511
STOP51T/GN	giallo nero	360x1010	3 metri	0768855778511
STOP51T/BR	bianco rosso	360x1010	3 metri	0768855778511
STOP51T/BI	bianco	360x1010	3 metri	0768855778511
STOP51T/V	verde	360x1010	3 metri	0768855778511
STOP51T/AR	arancio	360x1010	3 metri	0768855778511
STOP51T/GI	giallo	360x1010	3 metri	0768855778511

MISURE IMBALLO (mm/kg)

Codice	n. art. per imballo	Dim. imballo	Peso art.	Peso art. e imballo
STOP51T/R	2	390x1020x150	9,00	22,00
STOP51T/B	2	390x1020x150	9,00	22,00
STOP51T/N	2	390x1020x150	9,00	22,00
STOP51T/GN	2	390x1020x150	9,00	22,00
STOP51T/BR	2	390x1020x150	9,00	22,00
STOP51T/BI	2	390x1020x150	9,00	22,00
STOP51T/V	2	390x1020x150	9,00	22,00
STOP51T/AR	2	390x1020x150	9,00	22,00
STOP51T/GI	2	390x1020x150	9,00	22,00