









**STRUTTURA**

-  MATERIALE: acciaio inox
-  FINITURA: acciaio spazzolato
-  INDOOR/OUTDOOR
-  PESO: 10 kg

**GRAFICA**

-   MONOFACCIALE/BIFACCIALE
-  PERSONALIZZAZIONE

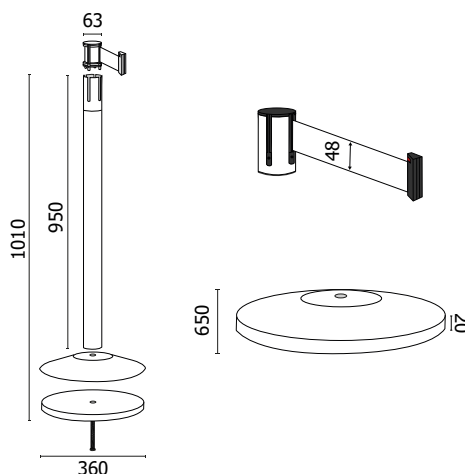

**NASTRO**

-  MATERIALE: polipropilene
-  COLORE: rosso
-  COLORE: blu
-  COLORE: nero
-  COLORE: bianco
-  COLORE: verde
-  COLORE: giallo
-  COLORE: arancione
-  COLORE: bianco/rosso
-  COLORE: nero/giallo
-  COLORE: grigio

Colonnine tendinastro in acciaio Inox con finitura spazzolata, dotate di sistema tendinastro autofrenante e 3 agganci riceventi. Base in cemento con copertura superiore in acciaio inox finitura spazzolata e guarnizione inferiore anti-scivolo. Nastro in polipropilene altezza 48 mm, resistente agli agenti atmosferici di lunghezza 3 mt con clip di sicurezza finale. Personalizzabile da entrambi i lati con logo ad 1 o più colori. Peso totale kg 10. Anello antiruggine in ABS nero per utilizzo interno ed esterno.

**DIMENSIONI PRODOTTO (mm)**

Codice	Colore nastro	Dim. ØxH	Lunghezza nastro	Cod. EAN
<b>STOP51/R</b>	rosso	360x1010	3 metri	0755899243082
<b>STOP51/B</b>	blu	360x1010	3 metri	0755899243037
<b>STOP51/N</b>	nero	360x1010	3 metri	0755899243075
<b>STOP51/GN</b>	giallo nero	360x1010	3 metri	0755899248407
<b>STOP51/BR</b>	bianco rosso	360x1010	3 metri	0755899248414
<b>STOP51/BI</b>	bianco	360x1010	3 metri	0755899243044
<b>STOP51/V</b>	verde	360x1010	3 metri	0755899243099
<b>STOP51/AR</b>	arancio	360x1010	3 metri	0755899261659
<b>STOP51/GI</b>	giallo	360x1010	3 metri	0755899261666
<b>STOP51/GR</b>	grigio	360x1010	3 metri	0768855795709
<b>STOP55</b>	-	360x1010	-	0755899243198

**MISURE IMBALLO (mm/kg)**

n. art. per imballo	Dim. imballo	Peso art.	Peso art. e imballo
2	390x1020x150	10,00	22,00