









### STRUTTURA

-  MATERIALE: acciaio inox
-  FINITURA: cromato lucido
-  INDOOR/OUTDOOR
-  PESO: 10,5 kg

### GRAFICA

-  MONOFACCIALE/BIFACCIALE
-  PERSONALIZZAZIONE

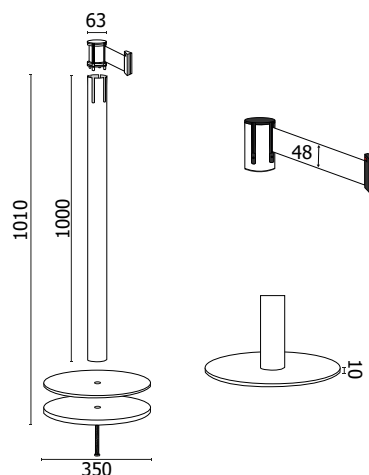

### NASTRO

-  MATERIALE: polipropilene
-  COLORE: rosso
-  COLORE: blu
-  COLORE: nero
-  COLORE: bianco
-  COLORE: verde
-  COLORE: giallo
-  COLORE: arancione
-  COLORE: bianco/rosso
-  COLORE: nero/giallo
-  COLORE: grigio

Colonnine Tendilinea con base piatta antinciampo e antiscivolo, montante in acciaio inox cromato lucido. Peso totale kg 10,5. Dotate di anello antiruggine in ABS nero. Tappo superiore con tre clip riceventi e nastro in polipropilene di lunghezza 3 m con sistema autofrenante e clip di sicurezza, personalizzabile da entrambi i lati con logo ad 1 o più colori. Anello antiruggine in ABS nero per utilizzo interno ed esterno.

### DIMENSIONI PRODOTTO (mm)

Codice	Colore nastro	Dim. ØxH	Finitura colonnina	L nastro	Cod. EAN
<b>TEND001L/R</b>	rosso	350x1010	cromato lucido	3 metri	0768855778276
<b>TEND001L/B</b>	blu	350x1010	cromato lucido	3 metri	0768855778252
<b>TEND001L/N</b>	nero	350x1010	cromato lucido	3 metri	0768855778269
<b>TEND001L/GN</b>	giallo nero	350x1010	cromato lucido	3 metri	0768855778313
<b>TEND001L/BR</b>	bianco rosso	350x1010	cromato lucido	3 metri	0768855778306
<b>TEND001L/BI</b>	bianco	350x1010	cromato lucido	3 metri	0768855778290
<b>TEND001L/V</b>	verde	350x1010	cromato lucido	3 metri	0768855778283
<b>TEND001L/AR</b>	arancio	350x1010	cromato lucido	3 metri	0768855778320
<b>TEND001L/GI</b>	giallo	350x1010	cromato lucido	3 metri	0768855778337
<b>TEND001L/GR</b>	grigio	350x1010	cromato lucido	3 metri	0768855795655

### MISURE IMBALLO (mm/kg)

n. art. per imballo	Dim. imballo	Peso art.	Peso art. e imballo
2	390x1020x150	10,50	23,00