



STOP 11 Colonnine segnapercorso



SCHEDA TECNICA



STRUTTURA

-  MATERIALE: ABS
-  FINITURA: nero opaco
-  INDOOR/OUTDOOR

GRAFICA

-  MATERIALE: telo banner
-  PERSONALIZZAZIONE
-  MONOFACCIALE

Struttura composta da: doppio aggancio in ABS nero con barra superiore porta banner roll-up in alluminio anodizzato silver L= 124,5 cm.

Traversa inferiore in alluminio anodizzato silver L= 121 cm completa di 2 attacchi laterali regolabili in ABS nero per tensionamento telo. Banner con telo personalizzabile in PVC non incluso.

Applicabile a tutte le colonnine con nastro.

STOP 11

Colonnine segnapercorso

SCHEDA TECNICA

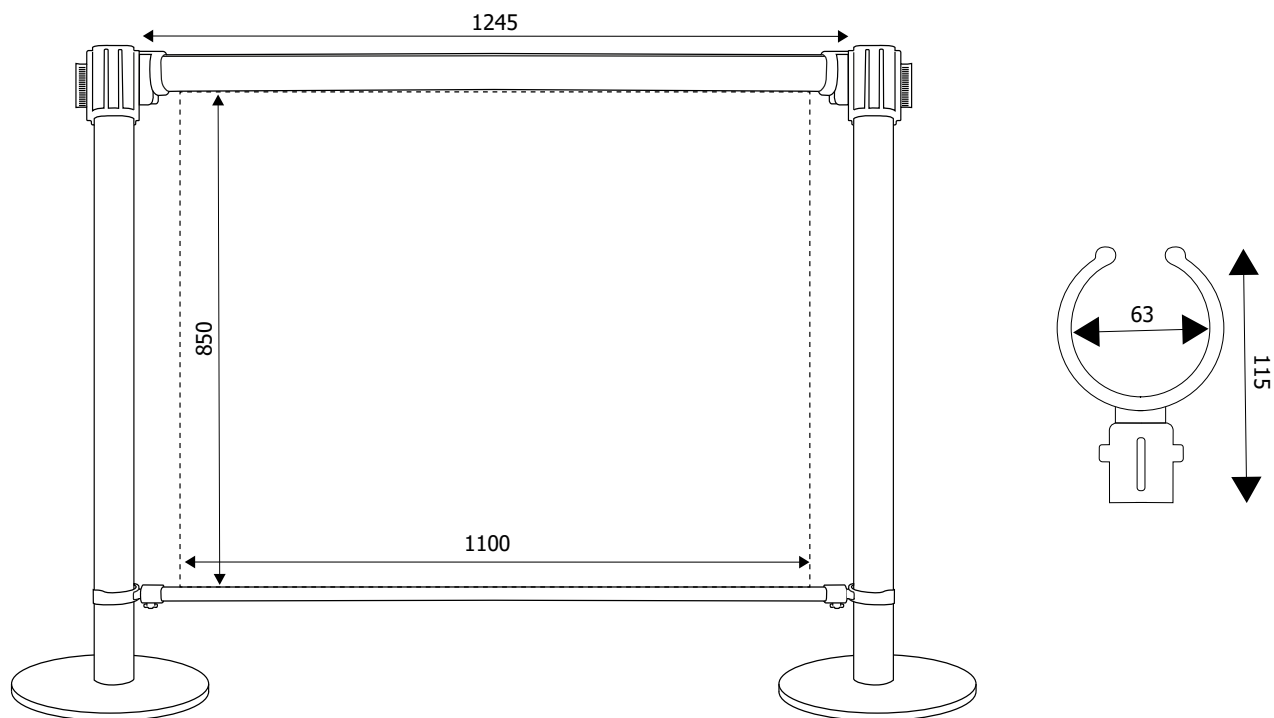

DIMENSIONI PRODOTTO (mm)

Codice	Dim. traversa sup.	Dim. traversa inf.	Dim. banner	Cod. EAN
STOP11	1245	1210	1100x850	0768855778887
STOP11/P1	stampa monofacciale 1100x850			0768855778894
STOP11/P2	stampa bifacciale 1100x850			0768855778900

MISURE IMBALLO (mm/kg)

Codice	Dim. imballo	Peso art.	Peso art. e imballo
STOP11	1300x150x150	5	6