

STOP51 Colonnine segnapercorso

SCHEMA TECNICA

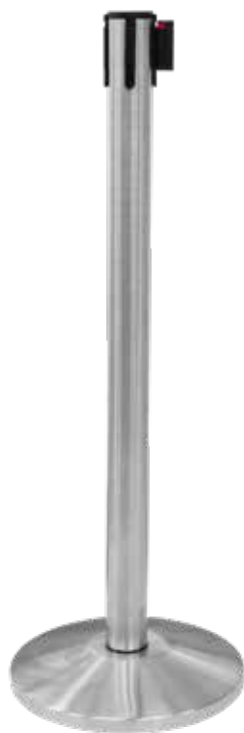



PROTEZIONE ANTIRUGGINE
ALLA FINE DELLACOLONNA











STRUTTURA

-  MATERIALE: acciaio inox
-  FINITURA: spazzolato
-  INDOOR/OUTDOOR
-  PESO: 10 kg

GRAFICA

-  PERSONALIZZABILE
-  MONOFACCIALE/BIFACCIALE

NASTRO

-  MATERIALE: polipropilene
-  COLORE: rosso
-  COLORE: blu
-  COLORE: nero
-  COLORE: bianco
-  COLORE: verde
-  COLORE: giallo
-  COLORE: arancione
-  COLORE: bianco/rosso
-  COLORE: nero/giallo

Colonnine tendinastro in acciaio Inox con finitura spazzolata, dotate di sistema tendinastro autofrenante e 3 agganci riceventi. Base in cemento con copertura superiore in acciaio inox finitura spazzolata e guarnizione inferiore anti-scivolo. Nastro in polipropilene altezza 48 mm, resistente agli agenti atmosferici di lunghezza 3 mt con clip di sicurezza finale. Personalizzabile da entrambi i lati con logo ad 1 o più colori. Peso totale kg 10. Anello antiruggine in ABS nero per utilizzo interno ed esterno.

STOP51

Colonnine segnapercorso

SCHEDA TECNICA

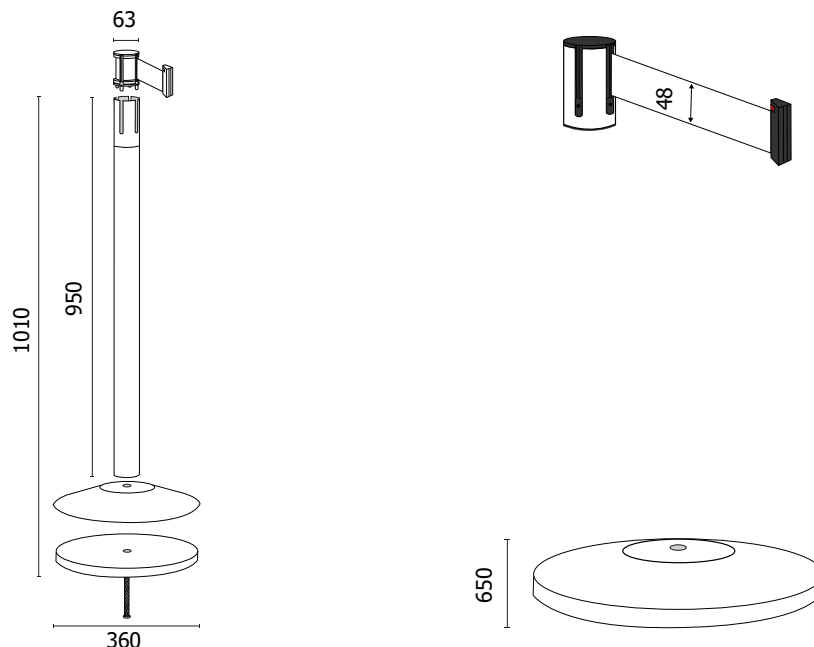

DIMENSIONI PRODOTTO (mm)

Codice	Colore nastro	Dim. ØxH	Lunghezza nastro	Cod. EAN
STOP51/R	rosso	360x1010	3 metri	0755899243082
STOP51/B	blu	360x1010	3 metri	0755899243037
STOP51/N	nero	360x1010	3 metri	0755899243075
STOP51/GN	giallo nero	360x1010	3 metri	0755899248407
STOP51/BR	bianco rosso	360x1010	3 metri	0755899248414
STOP51/BI	bianco	360x1010	3 metri	0755899243044
STOP51/V	verde	360x1010	3 metri	0755899243099
STOP51/AR	arancio	360x1010	3 metri	0755899261659
STOP51/GI	giallo	360x1010	3 metri	0755899261666
STOP55	-	360x1010	-	0755899243198

MISURE IMBALLO (mm/kg)

Codice	n. art. per imballo	Dim. imballo	Peso art.	Peso art. e imballo
STOP51/R	2	390x1020x150	10,00	22,00
STOP51/B	2	390x1020x150	10,00	22,00
STOP51/N	2	390x1020x150	10,00	22,00
STOP51/GN	2	390x1020x150	10,00	22,00
STOP51/BR	2	390x1020x150	10,00	22,00
STOP51/BI	2	390x1020x150	10,00	22,00
STOP51/V	2	390x1020x150	10,00	22,00
STOP51/AR	2	390x1020x150	10,00	22,00
STOP51/GI	2	390x1020x150	10,00	22,00
STOP55	2	390x1020x150	10,00	22,00